





Pos. Item Pos.	Ident-Nr. Ident-No N°d'ident	Bezeichnung	Designation Désignation
		Chassis CS9405	
	53 1195	Gebrauchsanweisung	operating instructions mode d'emploi
	53 5592	Service-Anleitung	service manual service instructions
	75 8640	Fernbedienung FB33	remote control telecommande
!	78 3155	Bildröhre A66EAK252X01	picture tube/tube image
		Abstimmbaustein mit Text	control unit with teletext
	75 9271	29504-103.73	panneau de commande avec Vt
w.	75 9495	29504-103.83	
!	75 9497	Bildrohrplatte RGB	picture tube/tube image
	75 9269	Farb RGB	RGB amplifier amplificateur F.I.
!	75 9334	Netzschaltereinheit	power switch unite interrupteur secteur
	—	SAT-Nachrüstsatz siehe FZ941S1	satellite reception module FZ941S1
	75 9266	Tuner (Hyperband)	tuner
	75 9267	ZF-Verstärker	IF-amplifier amplificateur F.I.
!		Sicherheitsbauteil	safety part
w.		wahlweise	alternatively/eligible

Pos. Item Pos.	Ident-Nr. Ident-No N°d'ident	Bezeichnung	Designation Désignation
	75 9274	Abdeckung f. EURO-AV-Buchse	cover/couvercle
	75 8435	f. Netzschalter/Kopfhörer	
	73 3712	Bildrohrfassung	picture tube socket tube image
	79 1208	Buchsen f. Kopfhörer 3,5 mm	jack/douille
	79 0662	Peri, schwarz	
	79 2099	Peri, blau	
	79 3750	Chassisbefestigung	chassis fixture attache chassis
!	78 3276	Entmagnetisierungsspule	demagnetizing coil bobine de desaimentation
!	73 9324	Fokus- und UG2-Regler	focus and UG2 VR
!	75 9496	Gerätestecker mit Kabel	unit collector with cable
	73 3713	Glimmerscheibe T568	mica disk rondelle mica
!	75 6674	Hochspannungskabel	high tension lead cable h.t.
	75 7961	Lautsprecher Breitb.	speaker haut parleur
	75 9272	Modulhalter f. ZF/FARBE/Abstimm- baustein	modul holder baquette couplage p. modul
!		Sicherheitsbauteil	safety part



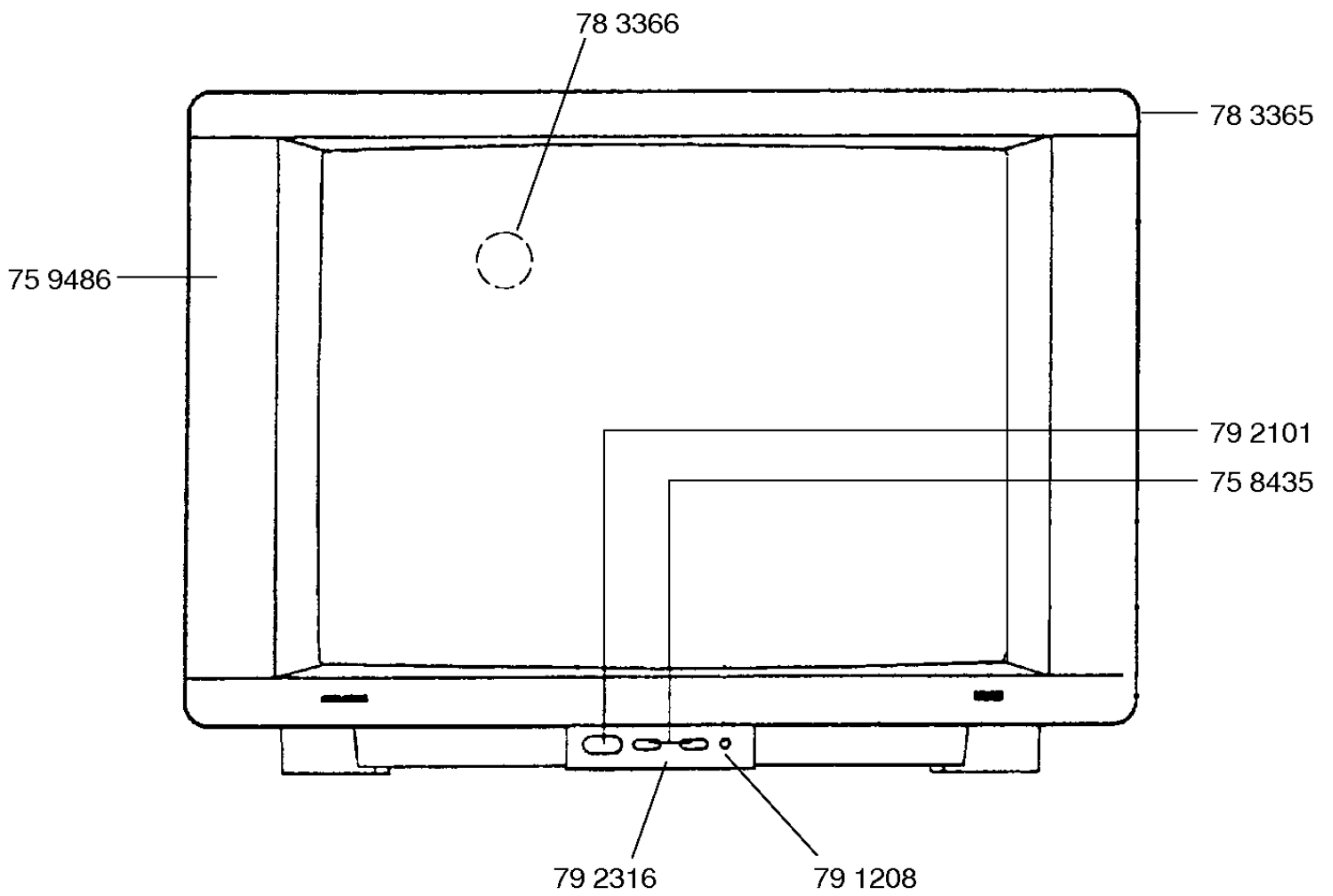

Pos. Item Pos.	Ident-Nr. Ident-No N°d'ident	Bezeichnung	Designation Désignation
			
SI505	! 79 1185	LOET-SI.-GR 315 MA/T	
SI601	! 73 6307	LOET-SI.-GR 2,5 A/T	
SI624	! 73 8400	LOET-SI.-GR 1,6 A/T	
SI677	! 79 2199	LOET-SI.-GR 2 A/T	
SI686	! 79 4336	LOET-SI.-GR 1 A/T	
SI688	! 79 2199	LOET-SI.-GR 2 A/T	
			
L501	73 8389	O/W Auskoppelspule	
L520	79 2760	Linearitätsregler (110)	
L554	79 5226	DR A AX-GA 47UH	
L601	! 73 5446	Funkentstördrossel	
L689	73 6349	Dämpfungspule	
			
TR501	! 79 1206	Treibertrafo	
TR525	! 75 9498	Trafo Dioden-Split kpl.	
TR651	! 75 9499	Trafo Sperrwandler kpl.	
	!	Sicherheitsbauteil	safety part

Pos. Item Pos.	Ident-Nr. Ident-No N°d'ident	Bezeichnung	Designation Désignation
			
CBR14S	79 5622	SMD 0 Ohm	
CBR23S	79 5622	SMD 0 Ohm	
CBR24S	79 5622	SMD 0 Ohm	
CBR25S	79 5622	SMD 0 Ohm	
CBR26S	79 5622	SMD 0 Ohm	
CBR33S	79 5622	SMD 0 Ohm	
CR5003	73 7722	470 Ohm 5%	
CR5038	73 7722	470 Ohm 5%	
CR5044	73 7722	470 Ohm 5%	
CR5091	73 7722	470 Ohm 5%	
R262	! 73 5814	12 Ohm	
R324	! 73 7493	1,8 Ohm	
R374	! 73 7493	1,8 Ohm	
R387	79 0146	18 Ohm	
R431	! 79 5237	10 Ohm 5%	
R435	! 79 5238	5,6 Ohm	
R436	! 79 4689	100 Ohm 5% TK100	
R502	79 4083	0,51 Ohm 10%	
R503	! 79 5248	5,6 Ohm 5%	
R516	73 4091	6,8 Ohm 10%	
R520	! 73 4890	820 Ohm 10%	
R525	! 73 7495	1 Ohm 10% 0,75 W	
R551	! 79 5646	7,5 Ohm 5%	
R554	! 79 4395	2,2 Ohm	
R598	! 73 3918	10 Ohm	
	!	Sicherheitsbauteil	safety part

Pos. Item Pos.	Ident-Nr. Ident-No N°d'ident	Bezeichnung	Designation Désignation
			
R600	! 79 5287	3,3 MOhm VDE	
R608	! 73 2974	DUO-PTC	
R623	73 2970	VDR SD/1 250V	
R624	! 79 2751	4,7 MOHM VDE	
R627	! 79 2751	4,7 MOHM VDE	
R674	! 79 5239	7W 2,7 Ohm	
R733	79 5530	9,1 KOhm	
R738	! 79 5510	56 KOhm	
R753	79 5530	9,1 KOhm	
R758	! 79 5510	56 KOhm	
R778	! 79 5510	56 KOhm	
R793	! 79 2208	330 Ohm	
R978	! 79 5240	3,3 Ohm	
R992	! 79 5240	3,3 Ohm	
R1850	! 79 5287	3,3 MOhm	
R5010	! 73 5814	12 Ohm	
R5164	! 73 3720	4,7 Ohm	
	!	Sicherheitsbauteil	safety part





Pos. Item Pos.	Ident-Nr. Ident-No N°d'ident	Bezeichnung	Designation Désignation
	73 4175	Montageklipp IC790	mounting clip clip de montage
	73 2585	T568/IC366/430	
	79 5154	T644	
	73 2584	IC680/690	
!	75 7906	Netzkabel (entstört)	power cord cordon secteur
!		Netzschalter	power switch interrupteur secteur
w.	73 2781		
	75 6363		
	79 2101	Tastenkнопf f. Netzschalter	power switch knob button interrupteur
	79 2316	Tastensatz Progr./Lautst.	key set jeu de touches
	78 2617	Typenaufkleber	typ label etiquette d'identification
	79 3886	Wärmeleitfolie T644/IC680/690	
!	79 1205	Winkelstecker 2-P Netz "Ein/Aus"	plug connecteur
w.		wahlweise	alternatively/eligible
!		Sicherheitsbauteil	safety part



Pos. Item Pos.	Ident-Nr. Ident-No N°d'ident	Bezeichnung	Designation Désignation
		FERNBEDIENUNG FB33	REMOTE CONTROL TELECOMMANDE
	75 8894	Gehäuse-Oberteil	cabinet upper part ébénisterie partie supérieure
	75 8341	Gehäuse-Unterteil	cabinet bottom part ébénisterie partie inférieure
	79 2317	Deckel (Batterie)	cover/couvercle
	75 8535	Kontaktmatte m. Tasten	contact surface surface de contact
	73 5709	Batteriefeder	battery spring branchement de batterie
Q906	73 5236	 485 KHz	
IC906	79 2341	 MC44107PA	
D907 D908	73 7161 73 9323	 TLN115A 1N4001	
T907	73 2803	 BC875	



Pos. Item Pos.	Ident-Nr. Ident-No N°d'ident	Bezeichnung	Designation Désignation
			
CD5037	79 5262	SMD DIODE LS4148	
CD5038	79 5262	SMD DIODE LS4148	
CD5067	79 5262	SMD DIODE LS4148	
CD5072	79 5262	SMD DIODE LS4148	
CD5089	79 5381	MELF-Z DIODE 6,2 C 0,5 W	
CD5148	79 5382	MELF-Z DIODE 5,1 B 0,5W	
D111	79 4467	ZTK 33 B/C	
D251	73 8425	Z DIODE 3,3 B 0,5W	
D252	73 9323	1N4001-GA	
D253	73 2963	Z DIODE 8,2 C 0,5W	
D256	73 9410	1N4148	
D266	73 9410	1N4148	
D381	79 5251	Z DIODE 10 C 0,5W	
D382	73 1743	BAT 42/43/BAT 85/86	
D383	73 9323	1N4001	
D431	79 2977	Z DIODE 51 C 0,5W	
D432	73 9410	1N4148	
D434	79 4468	Z DIODE 33 C 1,3W	
D437	70 9579	1N4002	
D502	73 2779	BYW76	
D503	79 0133	BY228	
D504	73 1729	TD129	
D532	73 3293	1N4004	
D548	73 9325	BAV21	
D551	79 0842	BYV28-200	
D556	79 0842	BYV28-200	
D572	79 0134	BA157/RGP10G	
D598	! 73 2776	BYV16TFK/BYV96E	
	!	Sicherheitsbauteil	safety part

Pos. Item Pos.	Ident-Nr. Ident-No N°d'ident	Bezeichnung	Designation Désignation
			
D620	73 2778	SKB380C1500L5B	
D641	79 3889	BYT53B	
D647	79 2757	BYT54M	
D648	79 2757	BYT54M	
D653	79 3889	BYT53B	
D661	79 3889	BYT53B	
D671	! 79 3892	BYW178/SK3G	
D674	! 79 2755	MUR420	
D674	! 79 3890	BYW172D/SK3G	
D677	! 79 2755	MUR420	
D677	! 79 3890	BYW172D/SK3GF0	
D686	! 79 2755	MUR420	
D686	! 79 3890	BYW172D/SK3G	
D688	! 79 3890	BYW172D/SK3G	
D688	! 79 2755	MUR420	
D692	73 9323	1N4001	
D694	73 2963	Z DIODE 8,2 C 0,5W	
D716	73 9410	1N4148	
D746	73 9410	1N4148	
D766	73 9410	1N4148	
D786	73 9410	1N4148	
D818	73 9410	1N4148	
D824	73 9410	1N4148	
D826	73 9410	1N4148	
D951	73 9410	1N4148	
D981	73 9410	1N4148	
D2203	73 9410	1N4148	
D6033	79 2359	LED TLHR 4601	
!		Sicherheitsbauteil	safety part

Pos. Item Pos.	Ident-Nr. Ident-No N°d'ident	Bezeichnung	Designation Désignation
			
IC102	79 2748	X24C04	
IC260	73 5586	TDA2822M	
IC366	79 2031	TDA7262	
IC430	79 2744	TDA8350Q	
IC631	79 2343	TDA4605/3	
IC680	73 5483	TDA8137	
IC690	73 4089	LM317T	
IC790	73 8163	TEA5101A/D	
IC810	79 2674	MC33164P-5RP	
IC820	79 5241	M27C1001-150NS	
IC830	79 2740	MC68 HC11 F1/FN4	
IC830	79 4327	MC68 HC11 F1/B4	
IC900	79 5161	MSP3400-15	
IC980	79 2014	TEA5114ATHO	
IC1800	79 2339	TFMS5300 (stehend)	
IC2210	79 5163	TDA6051-5	
IC2800	79 5242	SAA5281ZP/E	
IC5020	79 4466	4053B/14053BCP MOS	
IC5040	79 5165	TDA8376N1H	
IC5150	79 5166	TDA4665	
IC5160	79 5167	TDA4566	

Pos. Item Pos.	Ident-Nr. Ident-No N°d'ident	Bezeichnung	Designation Désignation
			
CT5005	73 6908	SMD BC857B	
CT5060	73 6908	SMD BC857B	
CT5065	73 0790	SMD BC848B	
CT5066	73 6908	SMD BC857B	
CT5075	73 0790	SMD BC848B	
CT5080	73 6908	SMD BC857B	
CT5085	73 6908	SMD BC857B	
CT5090	73 0790	SMD BC848B	
CT5095	73 0790	SMD BC848B	
CT5097	73 0790	SMD BC848B	
CT5107	73 6908	SMD BC857B	
CT5108	73 6908	SMD BC857B	
CT5109	73 0790	SMD BC848B	
CT5110	73 0790	SMD BC848B	
CT5113	73 0790	SMD BC848B	
CT5115	73 6908	SMD BC857B	
CT5116	73 0790	SMD BC848B	
CT5127	73 6908	SMD BC857B	
CT5128	73 6908	SMD BC857B	
CT5129	73 6908	SMD BC857B	
T107	72 3060	BC548C	
T251	72 4296	BC558C	
T256	72 2134	BC337-40	
T266	72 2134	BC337-40	
T381	72 2134	BC337-40	
T382	72 3060	BC548C	
T383	72 2134	BC337-40	

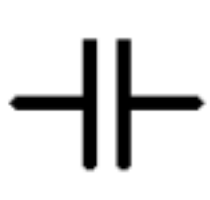
Pos. Item Pos.	Ident-Nr. Ident-No N°d'ident	Bezeichnung	Designation Désignation
			
T505	79 5288	BC637	
T531	73 7896	S298TTFK/PBF259	
T540	73 3284	BC549B	
T568	73 2771	BU508AON4542	
T644	79 5509	BC40	
T680	73 3284	BC549B	
T695	73 3284	BC549B	
T926	72 3060	BC548C	
T928	72 3060	BC548C	
T929	72 3060	BC548C	
T931	72 3060	BC548C	
T932	72 3073	BC548B	
T933	72 4296	BC558C	
T986	79 0854	BC558A	
T988	72 3073	BC548B	
T989	79 0854	BC558B	
T992	72 3073	BC548B	
T2221	79 0159	BC338-25	
T2225	72 4296	BC558A	
T2226	72 3073	BC548B	
T5006	79 0159	BC338-25	
			
F2213	73 7083	SPULE 7X7 600 FARBE 715	
F2226	73 4955	CER.TRAP 30	

Pos. Item Pos.	Ident-Nr. Ident-No N°d'ident	Bezeichnung	Designation Désignation
			
CC5167	79 5513	0,22 UF 10% 25V	
C518	79 5389	142PF 2,5% 2000V	
C601	! 73 7489	0,1 UF 20% 250VW	
C602	! 73 7489	0,1 UF 20% 250VW	
C603	! 73 7060	1000PF 20% 400V	
C604	! 73 7060	1000PF 20% 400V	
C621	73 4886	1000PF 20% 1KV	
C622	73 4886	1000PF 20% 1KV	
C623	73 4886	1000PF 20% 1KV	
C624	73 4886	1000PF 20% 1KV	
C648	73 7724	470PF 10% 1600V	
C666	! 73 5980	2200PF 20% 400V	
C716	73 4223	0,01 UF 20% 1500V	
			
Q826	79 2395	CER.RES.145 CSA 16,00 Mhz	
Q2803	79 0638	27 Mhz	
Q5054	79 4321	4,433619 Mhz	
			
	79 2158	Lautstärke +	
	79 2158	Lautstärke -	
w. !	73 2781	Netz	
w. !	75 6363	Netz	
	79 2158	Programm +	
	79 2158	Programm -	
w. !		wahlweise Sicherheitsbauteil	alternatively/eligible safety part